

PAPER • OPEN ACCESS

The Detection of Vertical Cracks in Asphalt Using Seismic Surface Wave Methods

To cite this article: M Iodice *et al* 2016 *J. Phys.: Conf. Ser.* **744** 012059

View the [article online](#) for updates and enhancements.

Related content

- [Effects of preparation process on performance of rubber modified asphalt](#)
Hanbing Liu, Guobao Luo, Xianqiang Wang *et al.*
- [Performance evaluation of high modulus asphalt concrete mixes](#)
V Haritonovs, J Tihonovs and M Zaumanis
- [Asphalt, resin and paraffin deposits from pumping and compression oil pipes removal process modeling](#)
R.T. Galiakbarov and A.D. Samigullin

Recent citations

- [Modelling the vibrational field of a single-layered ground containing a buried object](#)
G Duval and B Laulagnet



IOP | ebooks™

Bringing together innovative digital publishing with leading authors from the global scientific community.

Start exploring the collection—download the first chapter of every title for free.

The Detection of Vertical Cracks in Asphalt Using Seismic Surface Wave Methods

M Iodice, J Muggleton and E Rustighi

Institute of Sound and Vibration Research, University of Southampton; Southampton, United Kingdom

E_mail: erustighi@soton.ac.uk

Abstract: Assessment of the location and of the extension of cracking in road surfaces is important for determining the potential level of deterioration in the road overall and the infrastructure buried beneath it. Damage in a pavement structure is usually initiated in the tarmac layers, making the Rayleigh wave ideally suited for the detection of shallow surface defects. This paper presents an investigation of two surface wave methods to detect and locate top-down cracks in asphalt layers. The aim of the study is to compare the results from the well-established Multichannel Analysis of Surface Waves (MASW) and the more recent Multiple Impact of Surface Waves (MISW) in the presence of a discontinuity and to suggest the best surface wave technique for evaluating the presence and the extension of vertical cracks in roads. The study is conducted through numerical simulations alongside experimental investigations and it considers the cases for which the cracking is internal and external to the deployment of sensors. MISW is found to enhance the visibility of the reflected waves in the frequency wavenumber ($f-k$) spectrum, helping with the detection of the discontinuity. In some cases, by looking at the $f-k$ spectrum obtained with MISW it is possible to extract information regarding the location and the depth of the cracking.

1. Introduction

Non-destructive, *in-situ* methods for characterizing existing infrastructures require the ability to detect structural damage and features such as cracking and discontinuities. Damage in a pavement structure is usually initiated in the asphalt layers, making the Rayleigh wave ideally suited for the detection of shallow surface defects. The proper assessment of the location and of the extension of such discontinuities is crucial for the determination of the level of deterioration of an infrastructure and for decisions regarding maintenance, strengthening and rebuilding of existing infrastructures.

Detection of vertical cracking is normally based on the study of the reflections and refraction caused by the boundaries of the crack, even though reflections from cavity surfaces have weak energy and limited frequency range, making this process difficult to implement [1].

Numerical approaches to near-surface discontinuity detection show that the dispersion curve, and hence the wavefield, changes if the signal travels across a vertical discontinuity, which can be a crack or a slot [2]. The finite depth blocks shorter-wavelength Rayleigh waves, allowing only the longer wavelength to proceed and hence it acts as a low-pass filter. In general, cracks are likely to generate reflections and to change both the time history and the frequency content (the spectrum response) of a surface signal [1]. Moreover the edges of surface defects like cracks act like a source that excites surface waves which propagate along the crack surface [3, 4].



Various authors exploited the spectral ratio of the transmitted wave to the incident wave [5], the time-of-flight of the transmitted wave [4], the resonant effects of the scattering waves [3, 6] or leaky Rayleigh waves [7] to extract the information about the depth and the length of a surface crack, with ambiguous results. Other studies suggest a joint time-frequency analysis of the response for anomaly detection based on the wavelet transform [1].

In this work the potential of two common surface wave methods to be used as a crack detection tool is investigated with the aid of numerical and experimental investigations. The aim of this work is also to highlight the differences between the two approaches with respect to the detection of vertical discontinuities.

Only top-down cracking is considered in this study, i.e. cracks initiated from the surface and then expanding with depth. Two scenarios are investigated in the forthcoming investigations: when the vertical crack is external and when is internal with respect to the deployment of sensors.

1.1. Methods for the in-situ measurement of shear velocity in road pavements

Multichannel Analysis of Surface Waves (MASW) has been employed for profiling of pavement systems due to its advantages in dispersion measurement of irregular profiles [8, 9]. The set-up configuration consists of a source of seismic energy and multiple receivers (typically 24, but also up to 48 or more) placed on the ground surface with an equal spacing along a survey line (Figure 1) [10, 11]. The source offset and the spacing between receivers D are chosen according to the wavelength and hence the depth of investigation. The vertical ground vibration response is recorded simultaneously by all the receivers. MASW typically uses a continuous source like a vibrator or an impulsive source like a sledgehammer [12]. In MASW the experimental data can be analysed in the time domain or transformed from the time domain into different domains, typically the frequency-wavenumber ($f-k$) domain or the swept-frequency domain. Theoretically, the transformation of the wavefield into these domains allows the identification of different wave-types and higher order Rayleigh modes [13, 14], which significantly affect the determination of the actual phase velocity, as well as near-field and far-field effects [12]. The multichannel recording is a pattern recognition method enabling the identification of different types of seismic waves.

The possibility to analyse seismic data in different domains and hence the ability to discern different wave-types and different Rayleigh-modes of propagation make MASW the most used seismic technique for pavement dispersion evaluation.

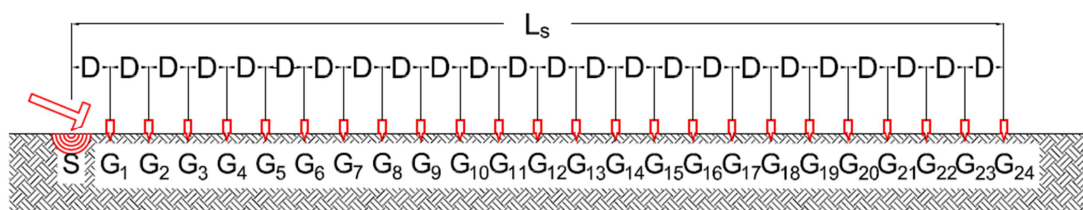

Figure 1. Typical MASW set-up configuration in the case of an isotropic medium with absence of discontinuity, where G refers to a geophone, S refers to a source of seismic energy, D is the receiver spacing, L_s is the length of the deployment of sensors.

When MASW is used to determine the shear wave velocity (V_s) profile, the soil is usually assumed to behave as a isotropic horizontal layered model with no lateral variation in elastic properties [15]. Disadvantages of a long deployment have been observed by many researchers: horizontal heterogeneities, anisotropies, and vertical and horizontal misalignments can lead to perturbations on the estimation of the phase velocity [10, 16]. Although the suitability of MASW testing for pavement

layers is undoubted, the methods share the same shortcomings existing in the case of soil and some additional problems arising when testing pavements: generation of high frequency energy, in order to evaluate the properties of thin shallow layers (up to 20kHz) is required, coupling between sensors and shallow surface is often tricky and complicated to achieve, finer inversion techniques to be used and more *a-priori* information are required, e.g. the number and the thicknesses of the road layers and their density.

Multiple Impact Surface Waves (MISW) [11, 17] is an alternative to the common MASW technique in order to obtain a multichannel record: sometimes a true multichannel survey can be cumbersome, requiring many bulky receivers deployed simultaneously in a small area. MISW consists in the deployment of a limited number of sensors (possibly up to only one) and in the generation of seismic waves by means of several hammer impacts (Figure 2). The source is consecutively moved by the same distance along the survey line: eventually, a simulated multichannel record is constructed by compiling the subsequent seismic traces. Since the coupling between asphalt surface and sensors can be difficult to achieve, it becomes quite advantageous in case of road surveys.

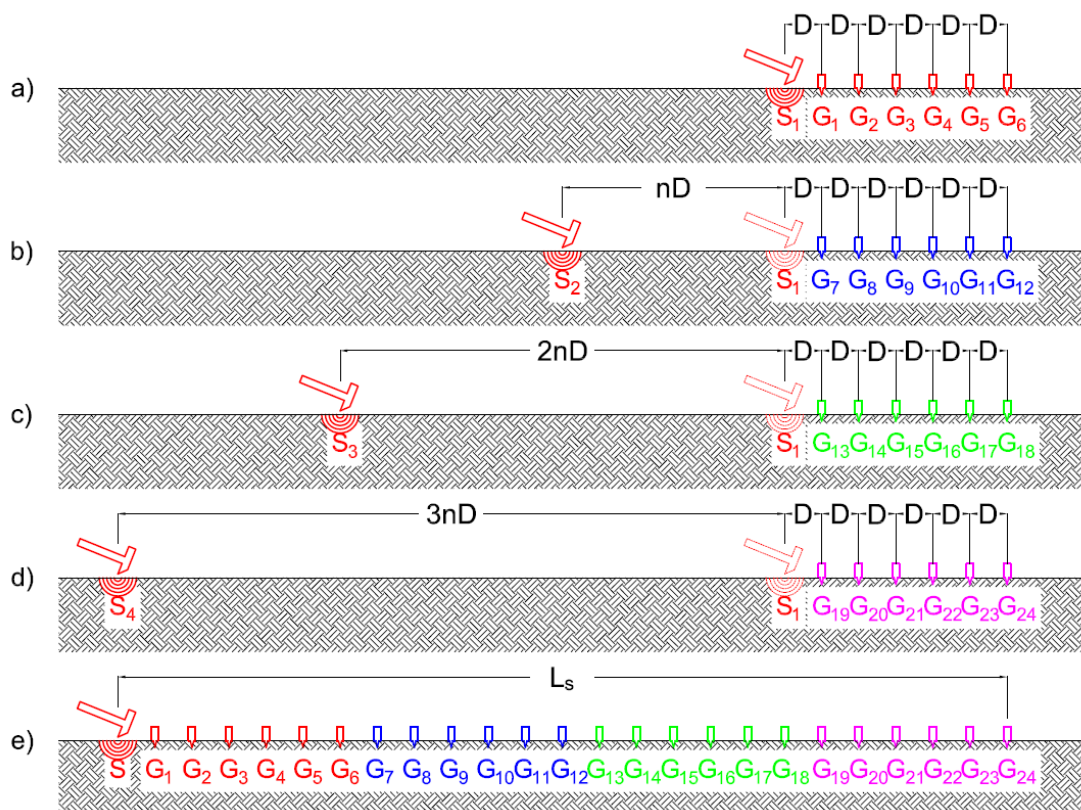

Figure 2. Typical MISW set-up configuration in the case of an isotropic medium with absence of discontinuity, where G refers to a geophone, S refers to a source, D is the receiver spacing, n is the number of receivers, L_s is the length of the deployment of sensors. The source is consecutively moved apart by the same distance from the first measurement (a) to the last (d) in order to construct an equivalent multichannel configuration (e). If mechanical properties do not change transversally, MISW and MASW surveys lead to the same results.

MISW leads to the same seismic spectrum of MASW, provided that the same set-up configuration is used (in terms of length of the signal and of the array of sensors) and that the system investigated is

homogeneous, i.e. the mechanical properties not changing transversally, and with absence of longitudinal and transversal discontinuities and anomalies.

In this paper two scenarios are investigated: when the crack is located somewhere externally to the deployment of sensors and is possible to perceive the reflected wave, when the crack is internal and the direct wave is low-pass filtered. Figure 3 shows the MASW and MISW configuration adopted for the forthcoming numerical and experimental investigation in this work, when the discontinuity is external to the deployment of sensor. Figure 4 displays the MASW and MISW configuration adopted in the case of a discontinuity internal to the array of sensors. In both cases the configuration consists of an array of 24 sensors, equally spaced by the distance D , and a source of seismic energy.

This paper aims at understanding the differences between the two approaches in the presence of anisotropies due to vertical discontinuities, and at suggesting the best surface wave technique for evaluating the presence and extension of vertical cracks in roads.

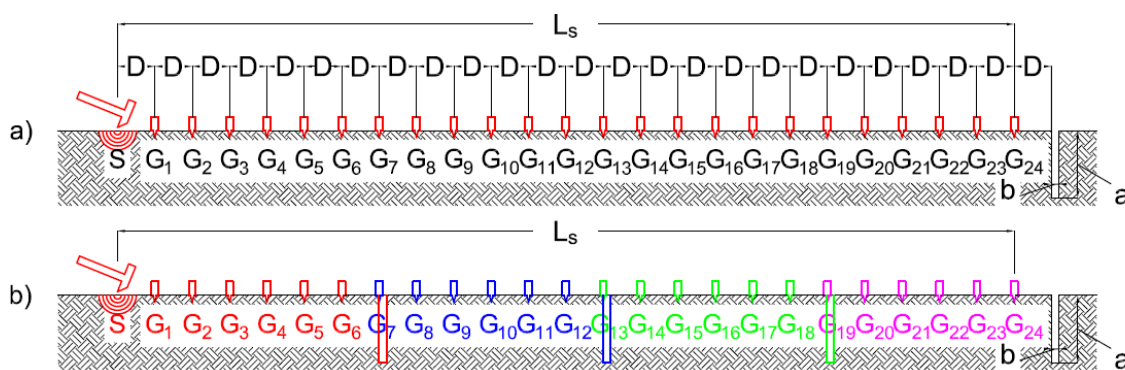

Figure 3. MASW set-up configuration (a) and MISW equivalent configuration (b) adopted for the forthcoming numerical and experimental investigation in the case of a discontinuity located outside the deployment of sensors. G refers to a geophone, S refers to a source, D is the receiver spacing, n is the number of receivers, L_s is the length of the deployment of sensors, a is the depth and b is the width of the discontinuity.

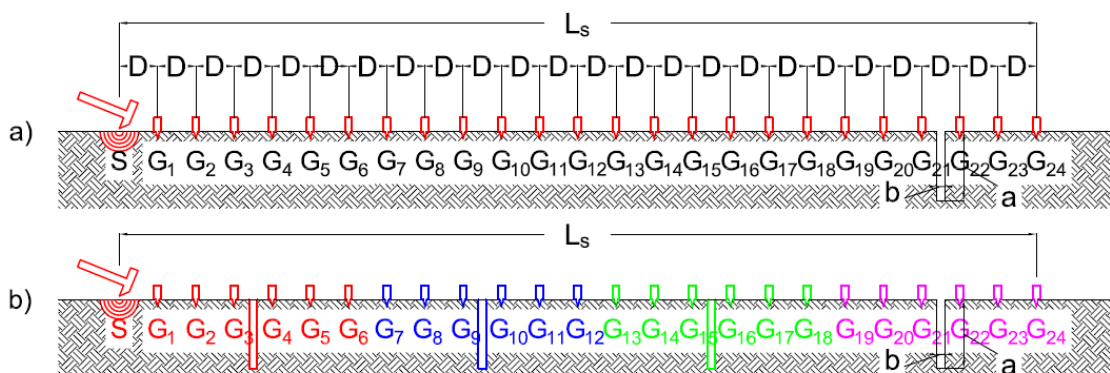

Figure 4. MASW set-up configuration (a) and MISW equivalent configuration (b) adopted for the forthcoming numerical and experimental investigation in the case of a discontinuity located inside the deployment of sensors. G refers to a geophone, S refers to a source, D is the receiver spacing, n is the number of receivers, L_s is the length of the deployment of sensors, a is the depth and b is the width of the discontinuity.

1.2. Frequency-Wavenumber transformation

The f - k transformation is essentially a two-dimensional Fourier Transform which transforms the vertical space-time domain representation $u(x,t)$ of a seismic event into the frequency-wavenumber representation $U(f,k)$: the time information is transformed into frequency components and the spatial information is transformed into wavenumber components. The peaks of the $U(f,k)$ spectrum are associated with the energy maxima and hence to the vibrational modes of propagation. The transformation is a well-established method and its properties are reported in many works [13, 18-21]. The resolution of the image in the f - k domain is inversely proportional to the length of the signal in time and to the length of the sensor line in space. The resolution is a key factor in separating the different modal contributions: often a peak in the f - k domain is not associated with a single mode, but is rather a superposition of several different modes. This can then lead to erroneous interpretation of the results.

Since the f - k transform is rotationally invariant, it is able to discriminate between direct positive going waves (characterized by positive wavenumbers) and negative going waves (characterized by negative wavenumbers) [22].

2. Numerical model

For the forthcoming simulations a finite/infinite element model (FEM) is assembled through the Abaqus/CAE software, in a single vertical plane, with the aim of studying the wave propagation in two-layered systems in the presence of a vertical discontinuity. The model is semi-elliptical in shape and each layer is considered to be elastic and isotropic.

Following the work of Zerwer [22], since we only are interested in surface wave measurements, the mesh element size progressively increases in the downward vertical direction. The mesh elements are smaller near the surface, where Rayleigh wave propagates, with an element size equal to l_{\max} . Infinite elements are applied to the boundaries of the model, behaving as many infinitesimal dashpots which are oriented normally and tangentially with respect to the boundary. The analysed profile consists of a layer over a half-space simulating a pavement road with irregular stratification (i.e. the velocity decreases with depth). Parameters are shown in Table 1. The following plane strain elements are utilized in the forthcoming simulation: CPE3 and CINPE4.

2.1. Model Constraints, Limitations and Attenuation

With finite elements methods, two discretization constraints should be adopted in order to achieve appropriate spatial and temporal resolution. The spatial condition assures that a sufficient number of points in space are sampled in order to recreate the wave, or in other word that the element size l_{\max} is small enough (it is the analogue of the Nyquist criterion in the time domain) [22, 23].

$$f_{\max} \leq \left(\frac{1}{8} \div \frac{1}{5} \right) \frac{V_S}{l_{\max}} \quad (1)$$

where V_S is the shear velocity and f_{\max} is the maximum frequency. The denominator is usually chosen to be well within the Nyquist limit.

The temporal constraint must be set after the spatial, to ensure that the wave front does not travel faster than the time step Δt . This is achieved using the Curant condition [22, 24, 25], here rearranged for two-dimensional problems:

$$\Delta t_{\max} \leq \frac{1}{V_P \sqrt{\frac{1}{l_{\max}^2}}} \quad (2)$$

where V_P is the compressional wave velocity.

Damping in numerical simulations is usually expressed as Rayleigh damping in terms of the mass damping α and the stiffness damping β , as follows [22, 24-26]:

$$\xi = \frac{1}{2\omega} \alpha + \frac{\omega}{2} \beta \quad (3)$$

Where ξ is the damping ratio and ω is the angular frequency of excitation.

It can be noticed that the damping ratio varies with the frequency of excitation. The values of α and β are usually selected according to engineering estimations, such that the critical damping ratio is set at two known frequencies.

The parameters of the model are reported in Table 1. The mechanical parameters have been chosen to represent a pavement system, with a stiff layer over a softer layer. The discontinuity is a rectangular vertical notch infinitely long in the transversal direction; it is filled with vacuum and its dimensions a and b are equal to 0.18m and 0.01m respectively. All the simulations are carried out with a sampling frequency of 50kHz.

Table 1. Parameters of the FEM model.

Poisson ratio, ν	0.33
Mass density, ρ	2000kg · m ⁻³
Element size at the surface, l_{\min}	0.05m
Semi-major axis	10m
Semi-minor axis	7.5m
Time step, Δt	2 · 10 ⁻⁵ sec
Duration of the simulation T	0.10sec
Thickness upper layer, h	0.20m
Thickness half-space	∞
Mass damping, α	0
Stiffness damping upper layer, β_1	0.01 / (200 · 2 π)
Stiffness damping half-space, β_2	0.025 / (200 · 2 π)
Young's Modulus upper layer, E_1	2000MPa
Young's Modulus half-space, E_2	1000MPa

The load used in the simulation consists of a short Hanning window ranging from 0 to 0.0004sec, capable of properly exciting frequency up to a value of 3kHz.

3. Numerical investigation

Four different numerical simulations have been executed using the MASW and the MISW technique, on the aim of looking at the influences on the f - k spectra of a notch situated at the end of the deployment of sensors and in the middle of the deployment of sensors, following the configurations displayed in Figure 3 and Figure 4.

3.1. Numerical simulation with a crack external to the deployment of sensors

The first two simulations aim to compare the MASW and MISW techniques for detection of a crack situated outside the deployment of sensors and are executed with the spacing D equal to 0.05m.

With presence of a vertical discontinuity outside the deployment of sensors, the f - k spectrum obtained with a MASW technique shows energetic peaks corresponding to the direct Rayleigh modes of propagation (Figure 5a). These peaks carry the biggest amount of energy and are then associated with the red area in the spectrum. One can notice the presence of the negative going Rayleigh wave

reflected by the boundaries of the anomaly, characterized by negative wavenumbers and highlighted by the black arrow in Figure 5a. The energy associated to the reflected negative going wave is very weak and the reflection shows limited duration and high frequencies decaying very fast.

The f - k spectrum obtained with a MISW technique shows energetic peaks corresponding to the direct Rayleigh modes of propagation, as it happened with the MASW technique (Figure 5b), associated with the red area in the spectrum. One can notice the presence of additional energy peaks on the negative wavenumbers region. They are parallel to the direct Rayleigh wave and they are produced by the reflections from the faces of the vertical discontinuity. These energy peaks are distributed such as to follow the slope of the reflected negative going wave (negative wavenumbers). Moving the source and keeping the sensors in a fixed position adds a periodicity in the system (see Figure 3 and Figure 4) reflecting in fictitious energy peaks also in the positive wavenumber region. These peaks are highlighted by arrows in Figure 5b and they are spaced by an offset Δp proportional to the length L_s of the sensor deployment, as follows:

$$\Delta p = \frac{2\pi}{L_s} [\text{rad}/\text{m}] \quad (4)$$

In this simulation $\Delta p = 20.94$ rad/m. The reflections from the boundaries of the cavity are more energetic, hence more visible, if the MISW technique is adopted, as can be noticed from a comparison between the two f - k spectra. Using MISW in the presence of a discontinuity adds a periodicity in the system, as can be perceived by looking at Figure 3 and Figure 4, enhancing the phenomenon of reflection and making the detection of a vertical crack easier.

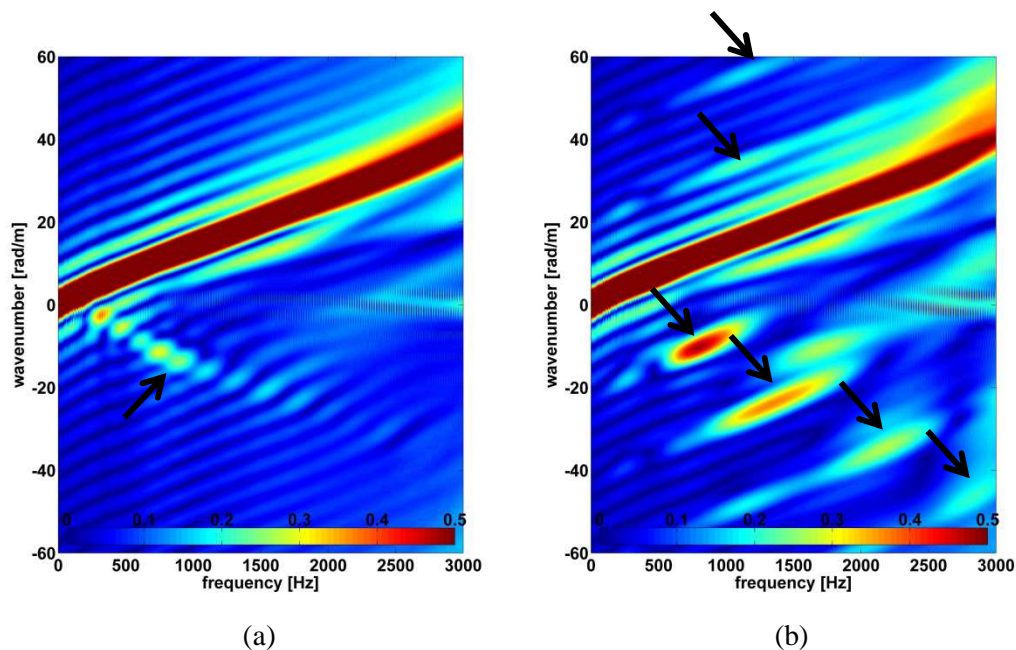

Figure 5. F - k spectrum obtained with MASW (a) and with MISW technique (b) from FEM simulations with a crack external to the array of sensors. The direct Rayleigh modes of propagation corresponds to the red most energetic peaks, black arrows highlight energy peaks produced by reflections from the faces of the vertical discontinuity.

3.2. Numerical simulation with a crack internal to the deployment of sensors

The last two simulations have the aim to compare MASW and MISW technique in the case of a crack situated inside to the deployment of sensors and they are executed with the configuration displayed in Figure 4 and with the spacing D equal to 0.10m. Moreover, the ultimate goal is to prove the effectiveness of the MISW technique for detection of vertical crack and for evaluation of the crack depth. As in the previous simulations, the f - k spectrum obtained with a MASW technique (Figure 6a) shows energetic peaks corresponding to the direct Rayleigh modes of propagation, corresponding to the red areas. Very weak reflected energy is present and visible in the form of energy peaks at negative wavenumbers (black arrows). By looking at the spectrum of Figure 6a, although is probably possible to speculate the presence of some sort of discontinuity, it is impossible to infer its location and depth. The f - k spectrum obtained with the MISW technique (Figure 6b) also shows energetic peaks corresponding to the direct Rayleigh modes of propagation, associated to the red areas. The presence of the energy peaks parallel to the direct Rayleigh wave, as discussed in section 3.1, is an indicator of the presence of the vertical discontinuity. These peaks are spaced by an offset Δp , following equation (4), and are highlighted by black arrows in Figure 6b. In this simulation $\Delta p = 10.50$ rad/m. Energy associated with reflection is much higher than the MASW case, helping for the detection of the vertical notch. Moreover, the energy associated to the direct Rayleigh wave, although noticeable until the frequency of approximately 2kHz, it becomes weaker all of a sudden starting from the frequency of 1kHz. This cut-off frequency is highlighted in the spectrum by a red arrow. The discontinuity acts as a low-pass filter, reflecting short-wavelength waves and allowing the passage of long-wavelength waves. This phenomenon indicates that the discontinuity is somewhere located inside the deployment of sensors, and its cut-off frequency could potentially suggest the depth of the discontinuity. Assuming a cut-off frequency of 1kHz and a V_R of 571m/s, it is possible to speculate a depth of about 0.19m for the vertical notch. The presence of energy for null wavenumber reflects the behaviour of the finite element modelling: the model sinks with infinite velocity since the problem is unconstrained.

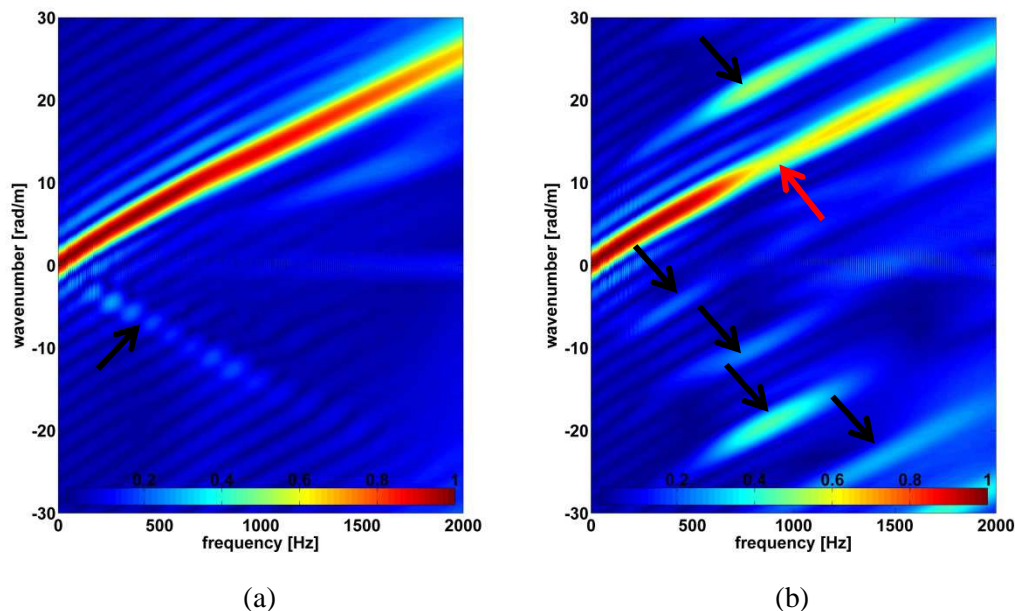

Figure 6. F - k spectrum obtained with MASW (a) and with MISW technique (b) from FEM simulations with a crack internal to the array of sensors. The direct Rayleigh modes of propagation corresponds to the red most energetic peaks, black arrows highlight energy peaks produced by reflections from the faces of the vertical discontinuity. The red arrow highlights the cut-off frequency due to the presence of the crack.

4. Experimental investigation

This experimental investigation consists of two different sessions: in the first session the two different seismic technologies are compared for the detection of a crack external to the array of sensors while in the second the MISW technique is adopted in a real case of a crack internal to the array of sensors.

4.1. Experimental investigation with a crack external to the deployment of sensors

The MASW experimental set-up consists of a source and an array of 24 geophones, arranged as in Figure 3a with a spacing D equal to 0.10m, covering an overall length L_s of 2.40m.

The MISW experimental set-up consists of a source and an array of 6 geophones, arranged as in Figure 3b and Figure 7 with the spacing D equal to 0.10m, covering a length L_s of 0.50m. The source is moved apart by 0.60m four times, resulting in a multichannel record of 24 traces covering an overall length L_s of 2.40m. Both deployments of sensors are 0.10m distant from a vertical discontinuity represented in this case by the transversal edge of the asphalt wearing course of the road.

The data is acquired using a ProSig P8020 data acquisition unit and a laptop. In the following experimental investigation all the tests are repeated and recorded 5 times with a sample frequency of 8kHz and duration L_f of 1sec, under the same input conditions, and then averaged in the frequency domain. For the purposes of this work, tri-axial geophones SM-24 from ION Sensor Nederland with a cut-off frequency of approximately 1kHz have been used.

The source consists of a 4-oz metallic mallet striking on a circular plate of 0.15m diameter, merely laid down the surface. The auto-spectrum computed from the signal of an accelerometer attached to the surface of the plate shows that the energy is evenly distributed over a range of frequencies varying from 10Hz to 4kHz.

The aim of this experimental session is to highlight the differences between the two technologies with respect to the detection of vertical discontinuities.



Figure 7. MISW experimental set-up configuration with the discontinuity outside the array of sensors (in this case the edge of the road pavement). On the right-hand side it is possible to see the hammer and the plate used as the impulsive source in this experiment.

The f - k spectrum obtained utilizing the vertical signals obtained from the MASW technique is showed in Figure 8a, whilst the spectrum obtained from the MISW technique is showed in Figure 8b.

In both spectra the biggest amount of energy corresponds to the direct Rayleigh wave propagation modes and it is associated with the red areas. The behaviour of the propagation modes of the Rayleigh wave follows that of layered irregular systems, i.e. system where the shear velocity decreases with depth. In this case there is a very visible mode jump associated with a change in the slope at the frequency of approximately 200Hz, which suggests a two-layered system. The frequency at which the mode jump occurs is likely to be related to the thickness of the upper layer. In fact the Rayleigh wave starts to propagate on the upper layer from a frequency of approximately 200Hz: assuming a Rayleigh wave phase velocity of 190m/s for the subgrade layer, the associated wavelength is 0.95m. Bearing in mind that the representative depth of ground roll is one third of its wavelength, the upper layer can be assumed to be approximately 0.30m thick. With the MASW technique only weak reflected energy is visible (black arrow in Figure 8a). It is not possible to realize the presence of a discontinuity by only looking at the spectrum of Figure 8a.

For the MISW test, additional energetic peaks parallel to the ones associated to the direct wave are visible. The presence of the energy peaks parallel to the direct Rayleigh wave are an indicator of the presence of the vertical discontinuity. These peaks are spaced by an offset Δp , following equation (4), and are highlighted by black arrows in Figure 8b. The reflections are enhanced when MISW is used in the proximity of a discontinuity, helping the detection of a vertical discontinuity. In this case $\Delta p = 10.50\text{rad/m}$.

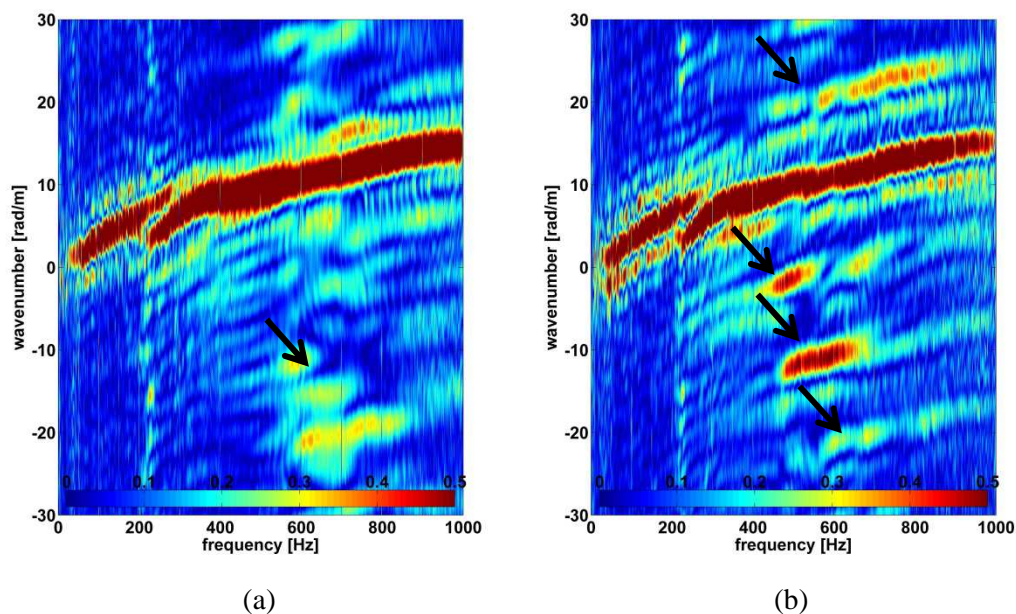

Figure 8. *F-k* spectrum obtained with MASW (a) and with MISW technique (b) from the experimental investigation with a crack external to the array of sensors. The direct Rayleigh modes of propagation corresponds to the red most energetic peaks, black arrows highlight energy peaks produced by reflections from the faces of the vertical discontinuity.

4.2. Experimental investigation with a crack internal to the deployment of sensors

A third experimental investigation is executed with the MISW technique to prove the effectiveness of the MISW technique for detection of a crack situated inside to the deployment of sensors, and it is executed with the configuration displayed in Figure 4b and Figure 9, with the spacing D equal to 0.10m. The multichannel record is obtained with the MISW technique, subsequently moving the

source by 0.60m four times, resulting in a multichannel record of 24 traces and length L_s of 2.40m. In this experimental session, a 0.01m wide vertical cracking in the surface is visible and symmetrically located between geophone 3 and geophone 4, internally to the geophone array. The data is acquired using a ProSig P8020 data acquisition unit and a laptop. In the following experimental investigation all the tests are repeated and recorded 5 times with a sample frequency of 8kHz and duration L_f of 1sec, under the same input conditions, and then averaged in the frequency domain. The source consists of a 4-oz metallic mallet striking directly onto the surface, with a flat frequency response ranging from 10Hz to 1500Hz.



Figure 9. MISW experimental set-up configuration with the discontinuity located in the middle of the array of sensors.

The f - k spectrum obtained utilizing the vertical signal recorded from the geophones is showed in Figure 10 and it displays energetic peaks corresponding to the direct Rayleigh modes of propagation, associated to the red areas. Once again, one can notice the presence of additional peaks of energy parallel to the direct Rayleigh wave modes of propagation. These peaks, highlighted in the spectrum with black arrows, are produced by the reflections when MISW is used in the presence of a vertical discontinuity. The offset between them is Δp and is proportional to the length L_s of the sensor deployment. In this case $\Delta p = 10.50 \text{ rad/m}$.

Albeit the content of energy associated with the direct Rayleigh wave is noticeable until the frequency of approximately 1kHz, it becomes weaker from the frequency of 600Hz. This behaviour is expected since it follows that of the numerical simulation (section 3.2). The cut-off frequency is highlighted by a red arrow in the f - k spectrum and is due to the presence of the crack, although possible cut-off frequencies are also noticeable at approximately 100Hz and 200Hz, probably due to the layered nature of the system. The vertical discontinuity allows only the passage of longer Rayleigh wavelengths, blocking the passage of the shorter ones, which are mainly reflected. Hence it acts as a low-pass filter. The depth of the discontinuity can be inferred from the chosen value of the cut-off frequency. Assuming a cut-off frequency of 600Hz and a Rayleigh wave phase velocity of 650m/s from the f - k spectrum, it is possible to speculate a depth of 0.36m for the crack, bearing in mind that the representative depth of ground roll is assumed equal to one third of the wavelength. Remembering the

frequency range of geophones, the maximum frequency detectable in these experimental sessions is approximately 1kHz.

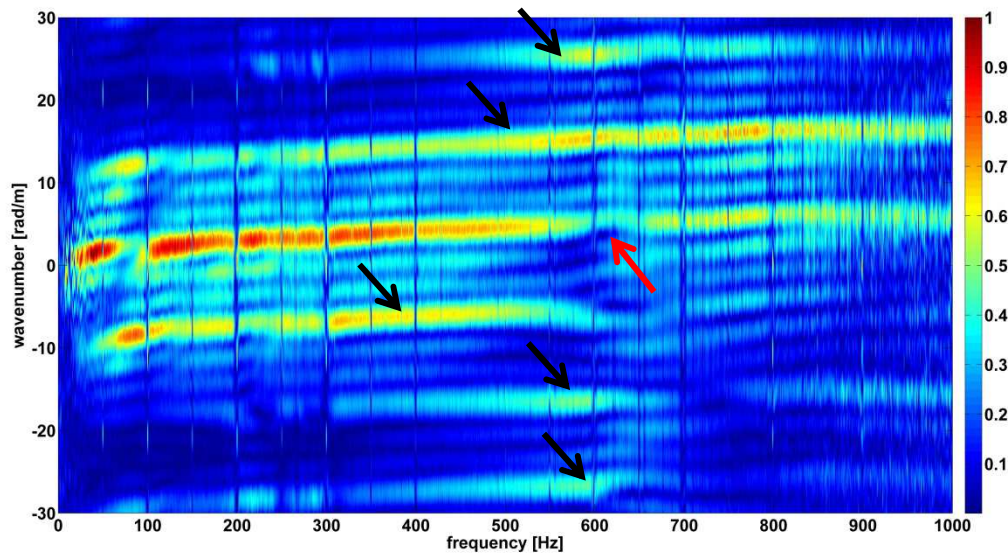

Figure 10. $F-k$ spectrum obtained with MISW technique from the experimental investigation with a crack in the middle of the array of sensors. The direct Rayleigh modes of propagation corresponds to the red most energetic peaks, black arrows highlight energy peaks produced by reflections from the faces of the vertical discontinuity when MISW is used. The red arrow highlights the cut-off frequency due to the presence of the crack.

5. Conclusions

Seismic wave methods based on the measurement of the propagation of Rayleigh wave are used for detection and identification of cracks in asphalt layers. The identification of vertical discontinuities is based on the exploitation of Rayleigh wave reflected from the surfaces of the anomaly.

MASW and MISW do not lead to the same $f-k$ spectrum if used in the presence of transversal anomalies.

MISW has found to enhance the visibility of the reflected waves in the $f-k$ spectrum: the sensors being close to the discontinuity magnify the content of the reflections in the signal allowing a more efficient detection of a vertical discontinuity in asphalt. In the presence of a discontinuity, MISW adds a periodicity in the system, which manifests itself as energy peaks parallel to the main propagation mode. The phenomenon of reflection is enhanced if MISW is used in the presence of a discontinuity.

A vertical discontinuity acts like a low pass filter, allowing the passage of longer wavelengths but blocking the passage and reflecting the short ones. By looking at the $f-k$ spectrum of a low-pass filtered Rayleigh wavefield obtained with the MISW approach it is theoretically possible to extract information regarding the location and depth of the cracking, but a wider investigation is needed.

The $f-k$ spectrum obtained with the MISW technique and with the set-up configurations used in this work carries more information than the same spectrum obtained with the MASW technique, making MISW better suited for crack detection.

6. Acknowledgements

The authors gratefully acknowledge the financial support of the UK Engineering and Physical Sciences Research Council under grant EP/K021699 “Assessing the Underworld – an integrated performance model of city infrastructures”.

7. References

- [1] N. Gucunski and P. Shokouhi, "Detection and characterization of cavities under the airfield pavements by wavelet analysis of surface waves," presented at the Worldwide Airport Technology Transfer Conference, Atlantic, 2004.
- [2] A. Zerwer, M. A. Polak, and J. C. Santamarina, "Rayleigh Wave Propagation for the Detection of Near Surface Discontinuities: Finite Element Modeling," *Journal of nondestructive evaluation* 22.2 (2003): 39-52, 2003.
- [3] V. Domarkas, B.T. Khuri - Yakub, and G. S. Kino, "Length and depth resonances of surface cracks and their use for crack size estimation," *Applied Physics Letters*, vol. 33, pp. 557-559, 1978.
- [4] M. Hirao and H. Fukuoka, "Scattering of Rayleigh surface waves by edge cracks: Numerical simulation and experiment," *The Journal of the Acoustical Society of America*, vol. 72, pp. 602-606, 1982.
- [5] G. Hevin, O. Abraham, H.A. Pedersen, and M. Campillo, "Characterization of surface cracks with Rayleigh waves: a numerical model," *NDT & E International*, vol. 31, pp. 289-297, 1998.
- [6] V. Domarkas, B. T. Khuri - Yakub, and G. S. Kino, "Length and depth resonances of surface cracks and their use for crack size estimation," *Applied Physics Letters*, vol. 33, pp. 557-559, 1978.
- [7] A. Fahr and W. R. Sturrock, "Detection and characterization of surface cracks using leaky Rayleigh waves," in *Review of Progress in Quantitative Nondestructive Evaluation*, ed: Springer, 1985, pp. 559-568.
- [8] C. B. Park, J. Ivanov, R. D. Miller, and J. Xia, "Seismic investigation of pavements by MASW method—geophone approach," in *Proceedings of the SAGEEP*, 2001.
- [9] C. B. Park, "Multichannel analysis of surface waves (MASW) for pavement-feasibility test," in *Proceedings of the 5th SEGJ International Symposium*, 2001.
- [10] S. Nazarian, "Shear Wave Velocity Profiling with Surface Wave Methods," *Geotechnical Engineering State of Art and Practice: Keynote Lectures from GeoCongress 2012*, pp.221-240, 2012.
- [11] N. Ryden, C. B. Park, P. Ulriksen, and R. D. Miller, "Multimodal approach to seismic pavement testing," *Journal of Geotechnical and Geoenvironmental Engineering* 130.6: 636-645, 2004.
- [12] C. B. Park, R. D. Miller, and J. Xia, "Multichannel Analysis of Surface Waves," *Geophysics* 64.3: 800-808, 1999.
- [13] S. Foti, S. Parolai, D. Albarello, and M. Picozzi, "Application of Surface - Wave Methods for Seismic Site Characterization," *Surveys in geophysics*, 32.6: 777-825, 2011.
- [14] A. Goel and A. Das, "A Brief Review on Different Surface Wave Methods and Their Applicability for Non- Destructive Evaluation of Pavements," *Nondestructive Testing and Evaluation: 337-350*, 2008.
- [15] C. B. Park, R. D. Miller, J. Xia, and J. Ivanov, "Multichannel Seismic Surface-Wave Methods for Geotechnical Applications," in *Proceedings of the First International conference on the application of geophysical methodologies to transportation facilities and infrastructure*, St. Louis, 2000.
- [16] L.V. Socco, S. Foti, and D. Boiero, "Surface-wave analysis for building near-surface velocity models—Established approaches and new perspectives," *Geophysics*, vol. 75, pp. 75A83-75A102, 2010.
- [17] P. K. M. L.D. Olson, "Multiple Impact Surface Waves (MISW) - Improved Accuracy for Pavement System Thickness and Moduli vs. Spectral Analysis of Surface Waves (SASW)," *GeoFlorida 2010@ sAdvances in Analysis, Modeling & Design. ASCE*, 2010.
- [18] C. B. Park, R. D. Miller, and J. Xia, "Multimodal analysis of high frequency surface waves," in *Proceedings of the symposium on the application of geophysics to engineering and environmental problems. Vol. 99. , 1999.*

- [19] T. Forbriger, "Inversion of shallow-seismic wavefields: I. Wavefield transformation," *Geophysical Journal International* **153.3**: 719-734, 2003.
- [20] S. Foti, R. Lancellotta, L. V. Socco, and L. Sambuelli, "Application of FK analysis of surface waves for geotechnical characterization," in *Proceedings of the fourth international conference on recent advances in geotechnical earthquake engineering and soil dynamics and symposium in honour of professor WD Liam Finn*, 2001.
- [21] A. Zerwer, "Near Surface Fracture Detection in Structural Elements: Investigation Using Rayleigh Waves," Doctor of Philosophy thesis, University of Waterloo, 1999.
- [22] A. Zerwer, G. Cascante, and J. Hutchinson, "Parameter estimation in finite element simulations of Rayleigh waves," *Journal of geotechnical and geoenvironmental engineering* **128.3** (2002): 250-261, 2002.
- [23] R. L. Kuhlemeyer and J. Lysmer, "Finite element method accuracy for wave propagation problems," *Journal of Soil Mechanics & Foundations Div* **99.Tech Rpt**, 1973.
- [24] C. T. Schroder and W. R. J. Scott, "A Finite-Difference Model to Study the Elastic-Wave Interactions with Buried Land Mines," *Geoscience and Remote Sensing, IEEE Transactions on* **38.4** (2000): 1505-1512, 2000.
- [25] C. T. Schroder, "On the interaction of elastic waves with buried land mines: an investigation using the finite-difference time-domain method," *Georgia Institute of Technology*, 2001.
- [26] E. L. Wilson, *Static and Dynamic Analysis of Structures (4th ed.)*, 2004.